

# LXP1-303 Limit Switch 行程开关

LXP1-303壳体尺寸

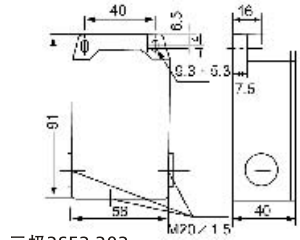

三极3E3 303  
Three-pole

LXP1-303/B

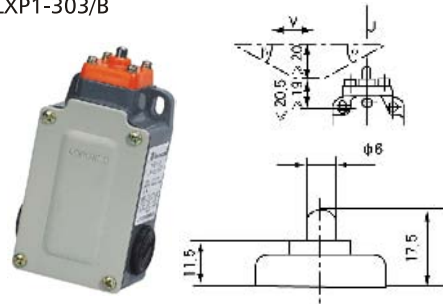

LXP1-303/C

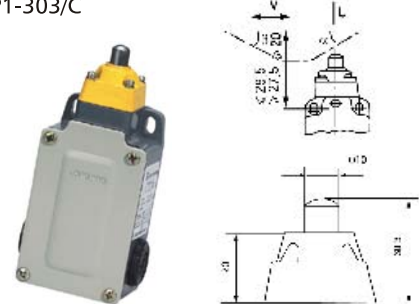

LXP1-303/D

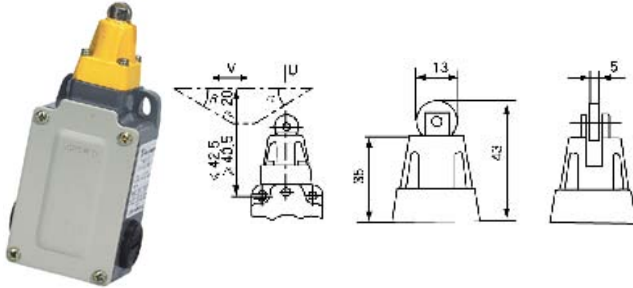

LXP1-303/E

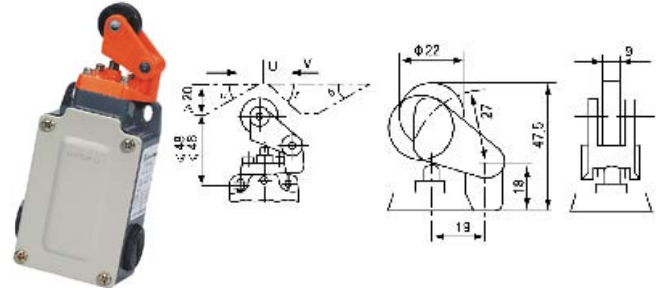

LXP1-303/F

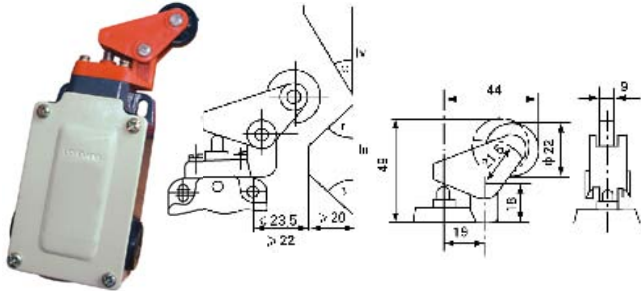

LXP1-303/G, J, H, K

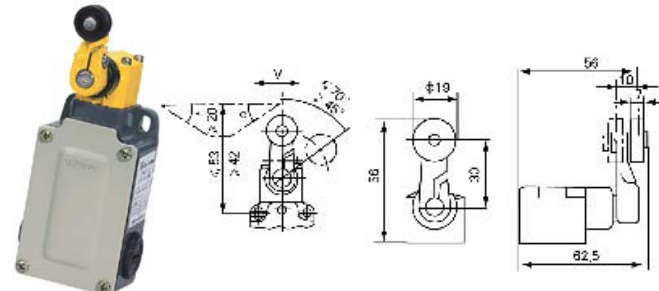

LXP1-303/T

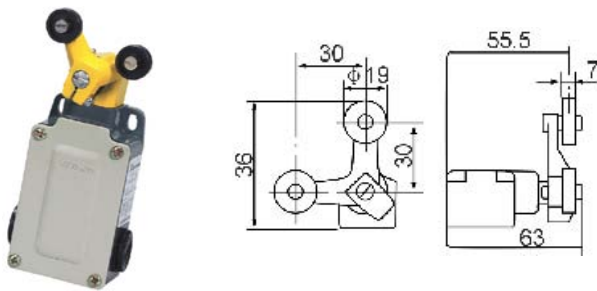

LXP1-303/U, N

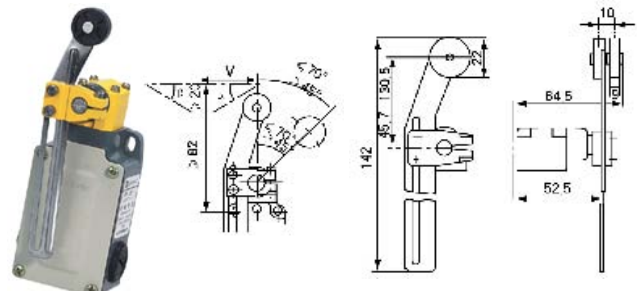

LXP1-303/P, Q, W, V

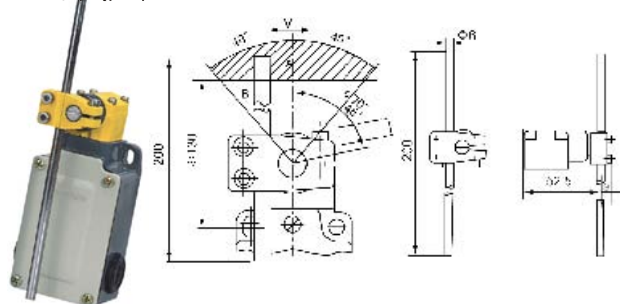

LXP1-303/R

